

TL3-1/9/1200V

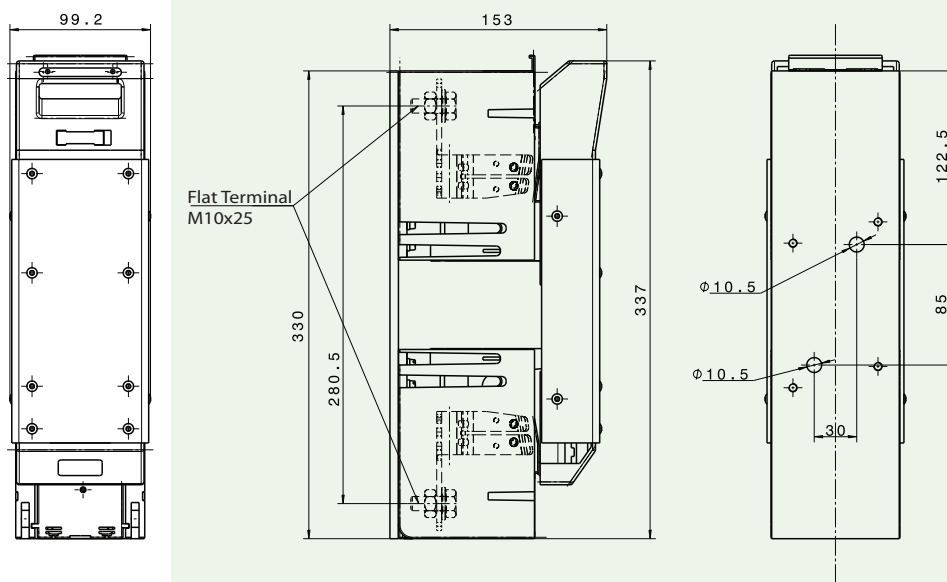

Izolirane letve za osigurače L2,3-2 / 1200V

Glavne karakteristike		L2	L3	
Tip		L2	L3	
Za NV rastalne uloške prema IEC 60269-6	Veličina	2 (produžen)	3 (produžen)	
Nazivni napon		1200V d.c.	1200V d.c.	
Nazivna struja		250A	400A	
Veličina rastalnog uloška		1XL, 2XL	3L	
Konvencionalna termička struja sa rastalnim uloškom		250A	400A	
Nazivni izolacioni napon		1200V d.c.	1200V d.c.	
Maks. dozvoljeni gubitak snage po rastalnom ulošku		46W	75W	
Kablovski priključci	Pljosnati priključci	Vijak	M12	
		Kablovski spojni element (DIN 46235)	1 x 25-240 mm ²	
		Sabirni priključci	30x10 mm	
		Moment pritezanja	35-40 Nm	
	Priključna spojnica KM2G	Presjek priključnih spojnica	25-150mm ² /185-300mm ²	
		Moment pritezanja	32 Nm	
		Priključna spojnica KM2G-F	Presjek priključnih spojnica	25-240 mm ²
			Moment pritezanja	32 Nm
Stepen zaštite - sprijeda, prekidač priključen – s prednje strane otvoren poklopac		IP10	IP10	
Radni uslovi	Temperatura okoline*	-25 ... +55		
	Radni uslovi	Neprekidni rad		
	Upravljanje	Zavisno ručno upravljanje		
	Montaža	Vertikalna, horizontalna		
	Nadmorska visina	do 2000 m		
	Stepen zagađenja	3		
	Stepen prenapona	III		

*35°C normalna temperatura, 55°C sa smanjenom radnom strujom



Izolirane letve za osigurače L2,3-2/1200V

Tip	I_n [A]	Šifra	Maks. priključak [mm ²]	Priključak	Težina [g]	Pakiranje [kom]
L2-2/1200/3A/HA/PV	250	004122039	25-240	Pljosnati priključak M12	3500	1
L2-2/1200/9/KM2G-F/HA/PV	250	004122040	25-240	Krletkasta spojnica KM2G-F	3650	1
L3-2/1200/3A/HA/PV	400	004122041	25-240	Pljosnati priključak M12	4110	1
L3-2/1200/9/KM2G-F/HA/PV	400	004122042	25-240	Krletkasta spojnica KM2G-F	4260	1

Pljosnati priključak M12

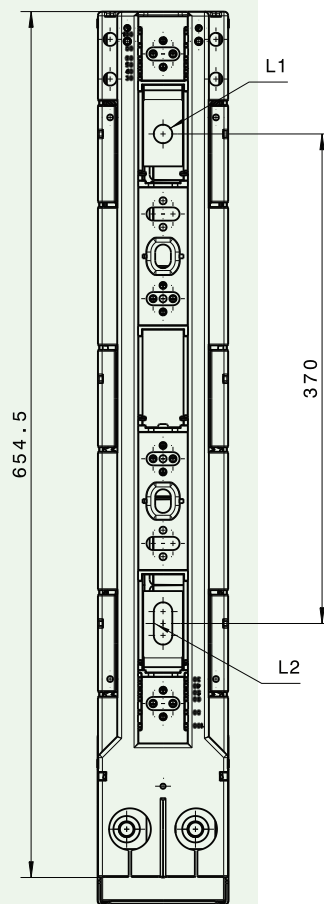
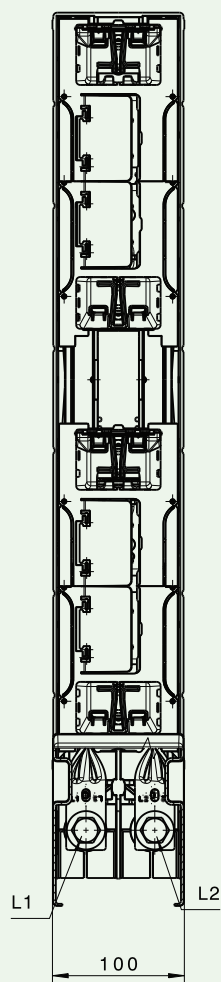
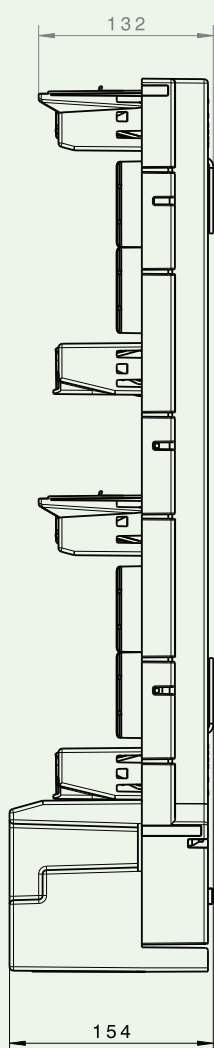



Krletkasta spojnica KM2G-F

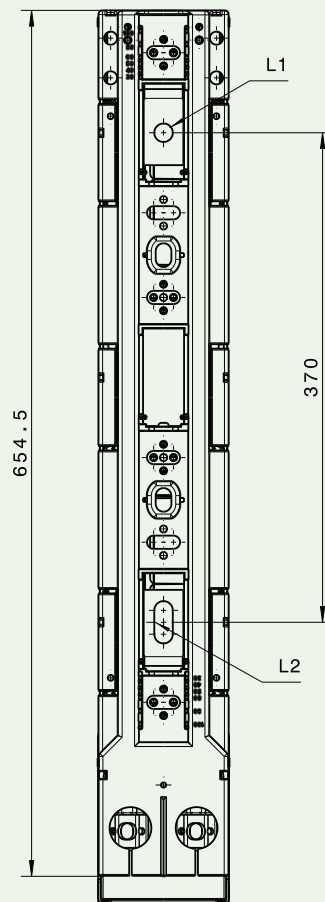
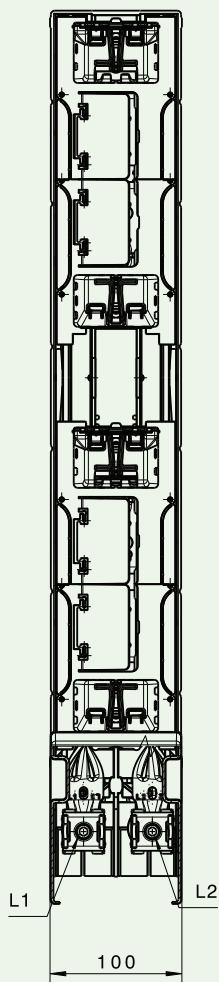
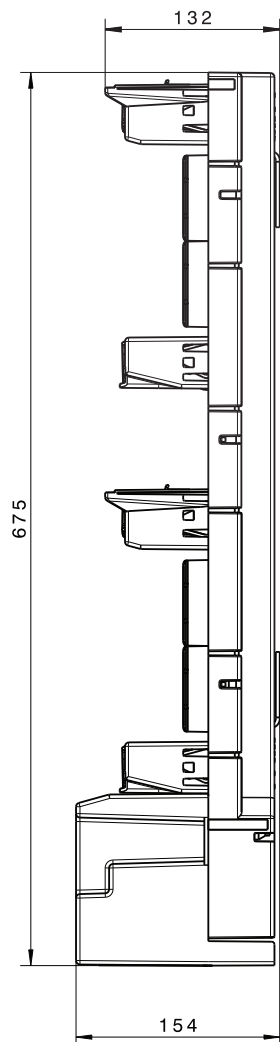

NV ručka

NV ručka za rastalni uložak DC 1100V

Šifra	Tip	Težina [g]	Pakiranje [kom]
004941112	GP 1200	400g	1

