

Switch disconnectors fuses LAF (NV-NH)

Generalities

LAF is a range of switch disconnectors fuse suitable for making and breaking on load and disconnecting low voltage electrical circuits. They are used for the following purposes:

- main switch
- switch for motors
- disconnector
- safety switch

They are available in 5 sizes

General characteristics

- rated insulation voltage 1000V AC and 1500 V DC
- 3-4 poles available
- high breaking capacity (AC-22,AC-23,IEC 60947-3)
- high electrical and mechanical endurance
- four break contacts per pole
- self - cleaning contacts

- both fuse terminals are not alive when the switch is in 0 position
- contact position positively indicated by the handle
- visibility of fixed and moving contacts by means of windows
- independent manual operation
- neutral contact open earlier and opens later than the phase contacts
- suitable protection to prevent accidental touching of live parts
- casing in self-extinguishing (V0-UL94), low hygroscopic and high mechanical resistance isolating material.
- resistant to damp heat (IEC 68-2)
- wide range of accessories
- rotary front operation by means of: external double insulated handle with door-interlock in ON position, IP65 degree of protection; padlockable with three padlocks in OFF position.
- direct handle (padlockable in OFF position on request)
- Conformity to standards: IEC 60947-1, IEC 60947-3, IEC 439-1, EN 60439-1, IEC 204-1,

Technical data for Switch disconnectors fuses LAF (NV-NH)

Type			LAF1	LAF2	LAF3	LAF4	LAF5	
Rated current	(I _n)		100A	125A	160A	250A	400A	630A
Rated insulation voltage	AC	(U _i) (V)	1000	1000	1000	1000	1000	1000
	DC	(U _i) (V)	1500	1500	1500	1500	1500	1500
Impulse withstand voltage	(U _{imp}) (kV)		8	12	12	12	12	12
Rated thermal current	(I _{th}) (A)		100	125	160	250	400	630
Rated current AC-21/A	400V	(A)	100	125	160	250	400	630
	500V	(A)	100	125	160	250	400	630
	690V	(A)	100	125	160	250	400	630
Rated current AC-22/A	400V	(A)	80	125	160	250	400	630
	500V	(A)	80	125	160	250	400	630
	690	(A)	80	125	160	250	400	630
Rated current AC-23/A	400V	(A)	80	125	160	250	400	630
	500V	(A)	63	100	125	200	315	500
	690V	(A)	45	80	100	160	250	400
Rated current DC-21A ⁽¹⁾	48V	(A)	100	125	160	250	400	630
	110V	(A)	100	125	160	250	400	630
	220V	(A)	100	125	160	250	400	630
	400V	(A)	-	125	160	250	400	630
	500V	(A)	-	125	160	250	400	630
	600V	(A)	-	-	-	-	400	630
Rated current DC-22A ⁽¹⁾	48V	(A)	80	125	160	250	400	630
	110V	(A)	80	125	160	250	400	630
	220V	(A)	80	125	160	250	400	630
	400V	(A)	-	125	160	250	400	630
	500V	(A)	-	125	160	250	400	630
	600V	(A)	-	-	-	-	400	630
Rated current DC-23A ⁽¹⁾	48V	(A)	80	125	160	250	400	630
	110V	(A)	80	125	160	200	315	500
	220V	(A)	63	125	160	160	250	400
	400V	(A)	-	125	160	-	-	-
Rated operational power at 400V AC-23-A	(kW)		42	65	85	130	210	330
Back up fuse	(A)		80	125	160	250	400	630
Short - circuit current - R.M.S. value	(kA)		100	50	50	50	50	50
Short - circuit current - peak value	(kA)		12	15	15	25	30	40
Rated making capacity at 420V AC cosφ 0,35 (0,45*)	(A)		800*	1250	1600	2500	4000	6300
Rated breaking capacity at 420V AC cosφ 0,35 (0,45*)	(A)		640*	1000	1280	2000	3200	5040
Rated making and breaking capacity at DC (230V L/R=15)	(A)		180	320	400	640	1000	1600
Rated capacitor power at 400V	(kVAR)		45	50	70	110	180	300
Mechanical endurance	n°		10000	8000	8000	7000	7000	4000
Electrical endurance	n°		1500	1000	1000	1000	1000	1000
Power loss per pole ⁽²⁾	(W)		1,2	4,8	4,8	12	19,2	30
Cable section (Cu)	mm ²		35	70	70	120	240	2 x 185
Bars dimensions (Cu)	mm		16x3	16x4	16x4	25x4	32x5	2x40x6
Operation torque	Nm		8	12	12	18	34	45

(1) two poles in series
(2) fuse-link not included

LAF1 - door interlock handle

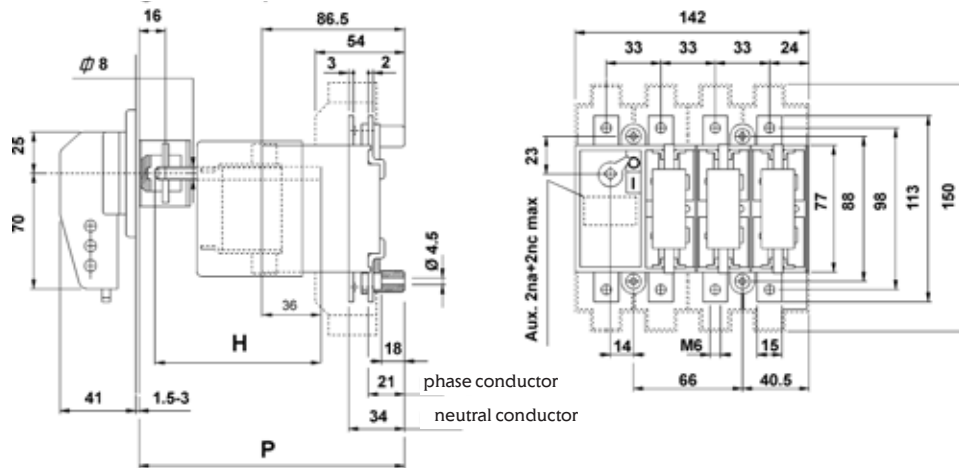

LAF1 - with direct handle

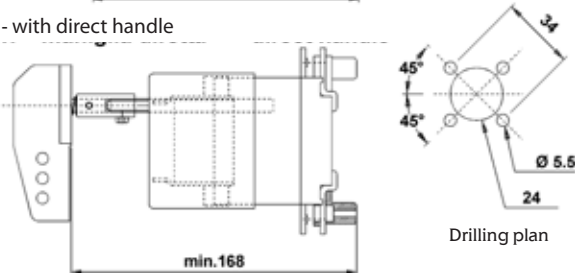

P		C	H
min	max		
157,5	260,5	60,5	P-C

C = constant

LAF2 - door interlock handle

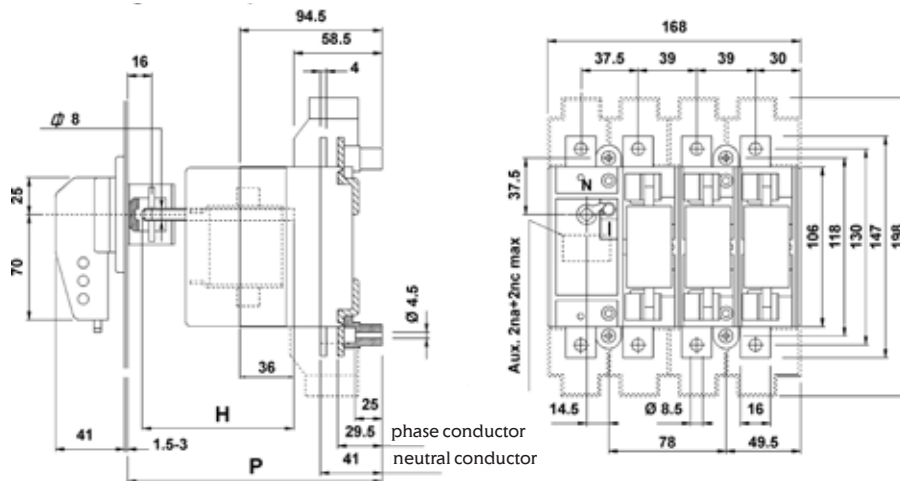

LAF2 - with direct handle

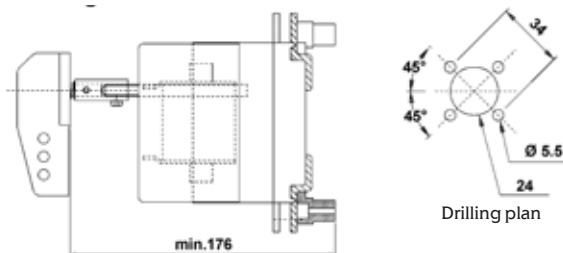

P		C	H
min	max		
165,5	268,5	68,5	P-C

C = constant

ETISWITCH

LAF3 - door interlock handle

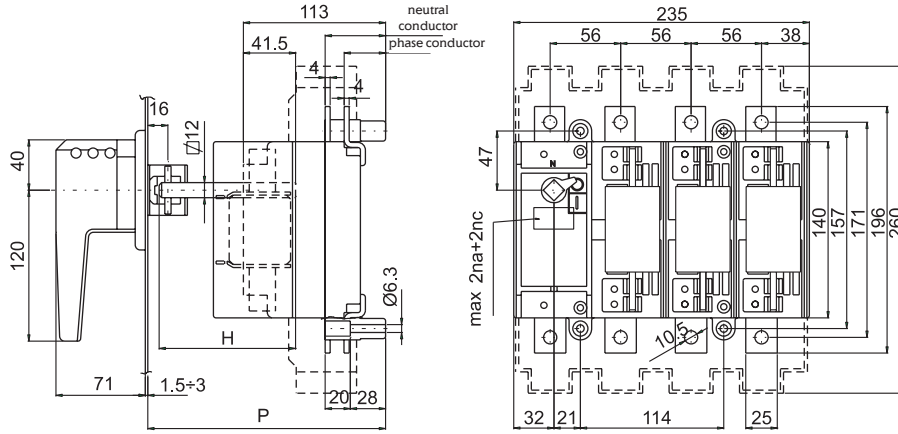

LAF3 - with direct handle

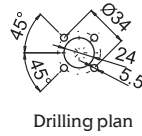
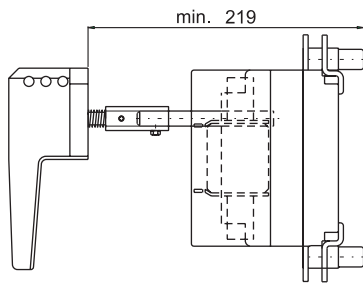

P		C	H
min	max		
189	280,5	71,5	P-C

C = constant

LAF4 - door interlock handle

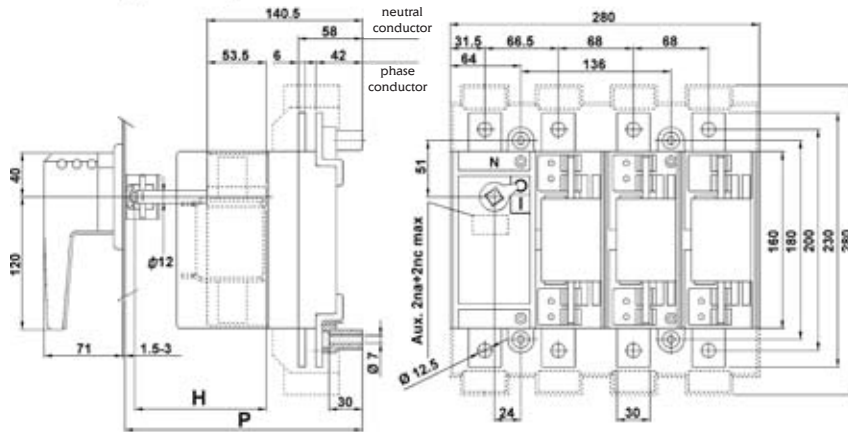

LAF4 - with direct handle

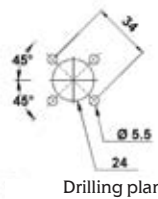
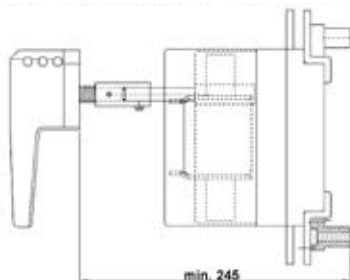

P		C	H
min	max		
215	296	96	P-C

C = constant

LAF 5 - door interlock handle

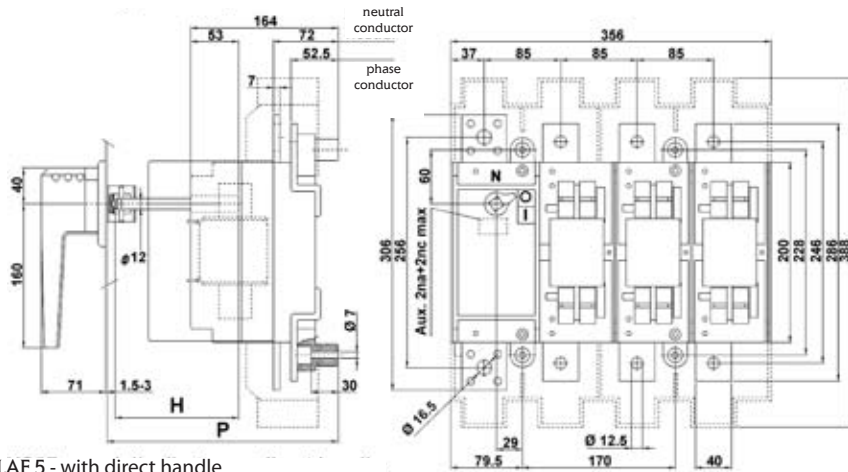

LAF 5 - with direct handle

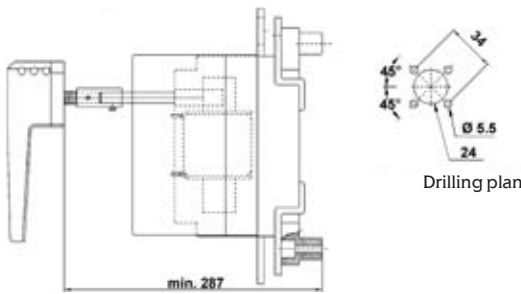

P		C	H
min	max		
257	320	120	P-C

C = constant

Door interlock handle/emergency with double function of security

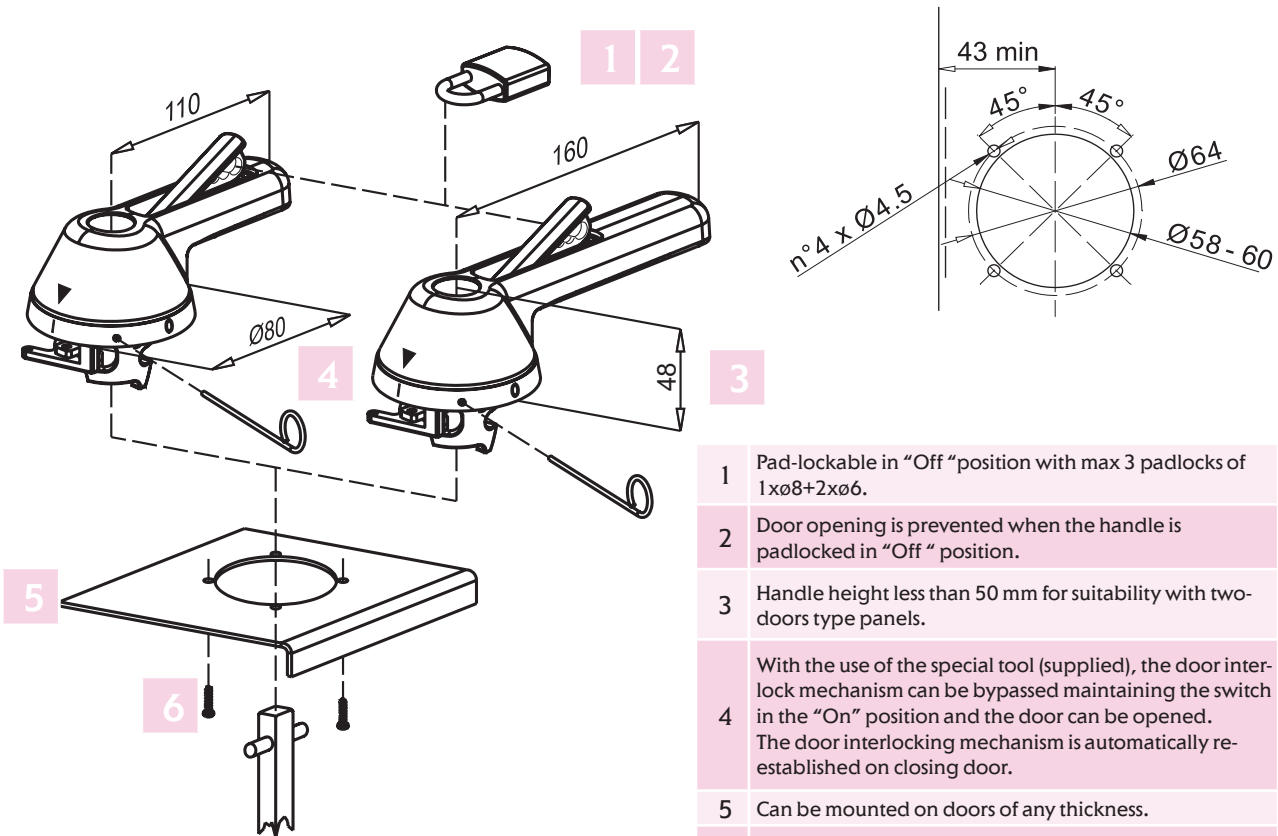

- 1 Pad-lockable in "Off" position with max 3 padlocks of 1xØ8+2xØ6.
- 2 Door opening is prevented when the handle is padlocked in "Off" position.
- 3 Handle height less than 50 mm for suitability with two-doors type panels.
- 4 With the use of the special tool (supplied), the door interlock mechanism can be bypassed maintaining the switch in the "On" position and the door can be opened. The door interlocking mechanism is automatically re-established on closing door.
- 5 Can be mounted on doors of any thickness.
- 6 Position of handle fixed when the door is open.